



Quiet &  
Comfortable  
with  
LG HVAC.

# LG AIR CONDITIONERS Ducted Split System

**Vitalising** You & Your Environment



# Enjoy Clean, Quiet, and Comfortable Air Conditioning with LG



## Making you and your environment more comfortable

LG has a comprehensive range of air conditioning solutions designed to suit a wide range of buildings or spaces.







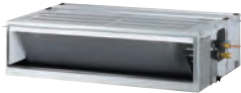

# DUCTED SPLIT SYSTEM

LG has a range of ducted air conditioners to suit with most type of home or office.

## Model Line-up

Ducted Split System				Capacity (kW)	EER/COP
<b>SLIM</b>	Low Static		Indoor <b>B18AWYNGMD</b>	Cooling 5.1	3.09
			Outdoor <b>B18AWYUGMD</b>	Heating 6.0	3.30
	Mid Static		Indoor <b>B24AWYNGMD</b>	Cooling 7.1	3.57
			Outdoor <b>B24AWYUGMD</b>	Heating 8.1	3.54
			Indoor <b>B36AWYNGMD</b>	Cooling 10.0	3.09
			Outdoor <b>B36AWYUGMD</b>	Heating 11.2	3.33
<b>PREMIUM</b>	High Static		Indoor <b>B30AWYN7G5</b>	Cooling 8.8	3.09
			Outdoor <b>B30AWYU4G5</b>	Heating 9.2	3.29
			Indoor <b>B36AWYN7G5</b>	Cooling 9.9	3.41
			Outdoor <b>B36AWYU4G5</b>	Heating 11.0	3.35
			Indoor <b>B42AWYN7G5</b>	Cooling 12.3	3.37
			Outdoor <b>B42AWYU3G5</b>	Heating 14.1	3.69
<b>STANDARD</b>	High Static		Indoor <b>B55AWYN7G5</b>	Cooling 15.0	3.09
			Outdoor <b>B55AWYU3G5</b>	Heating 17.1	3.29
			Indoor <b>B30AWYN7G5A</b>	Cooling 8.0	3.09
			Outdoor <b>B30AWYU4G5A</b>	Heating 8.8	3.29
			Indoor <b>B36AWYN7G5A</b>	Cooling 9.9	3.29
			Outdoor <b>B36AWYU4G5A</b>	Heating 11.0	3.28
<b>BIG DUCT</b>	High Static		Indoor <b>B42AWYN7G5A</b>	Cooling 12.3	3.01
			Outdoor <b>B42AWYU3G5A</b>	Heating 14.1	3.50
			Indoor <b>B55AWYN7G5A</b>	Cooling 14.2	3.00
			Outdoor <b>B55AWYU3G5A</b>	Heating 17.1	3.29
			Indoor <b>B62AWYN9L6</b>	Cooling 18.0	3.29
			Outdoor <b>B62AWYU7L6</b>	Heating 20.6	3.75
			Indoor <b>B70AWYN9L6</b>	Cooling 20.0	3.09
			Outdoor <b>B70AWYU7L6</b>	Heating 22.6	3.65

INVERTER

## Outdoor Unit







## USER FRIENDLY CONTROL

LG air conditioning solutions allow users to take advantage of a hassle-free, intuitive management system via the controller

## EASY INSTALLATION & MAINTENANCE

The built-in evaporator safety tray makes the product much easier to install and maintain. Must be installed by a licensed installer.



## HIGH RELIABILITY & COMFORT

LG latest technological innovations ensure greater overall system reliability as well as convenient benefits such as quick, stable cooling and a wider operation range than conventional systems.



## SMART APPLICATION

Easily access and control your Air Conditioner from your smart phone.

\* Wireless home network required



# RELIABILITY

The revolutionary inverter technology of LG boasts powerful performance while maximising reliability.



## ▶ POWERFUL BLDC COMPRESSOR

LG air conditioner comes with a BLDC compressor that uses a strong neodymium magnet. Its compressor has improved efficiency and the operation range has been expanded.



● **BLDC**  
Concentrated Winding

Operation Frequency

**15** ~ 100 Hz

## ▶ BLDC FAN MOTOR TECHNOLOGY

The BLDC motor is made up of powerful ND magnets providing high torque, resulting in the ability to provide large air volume and high static pressure capability. This allows high speed operation at reduced electrical and mechanical noise.

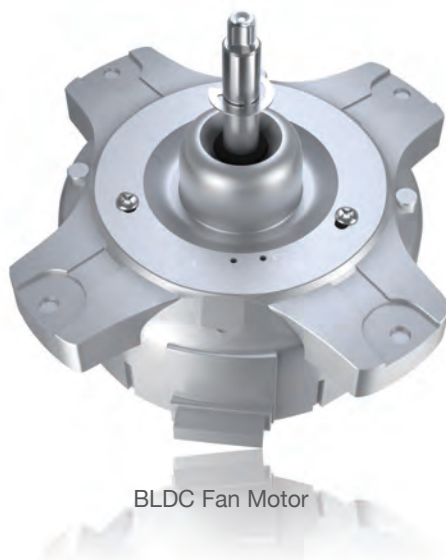

BLDC Fan Motor

- 1 Heat Exchanger
- 2 BLDC Fan Motor Technology
- 3 Powerful BLDC Compressor

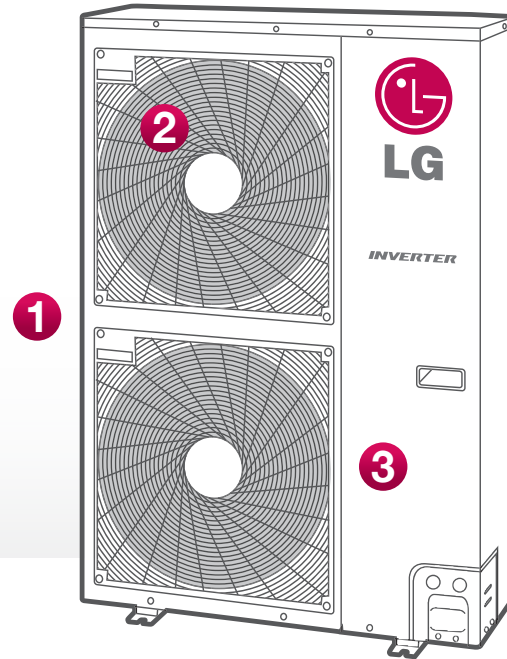

### HEAT EXCHANGER WITH WIDE LOUVER FIN

Improved heat exchanger efficiency up to 28%, applying Multi V technology.

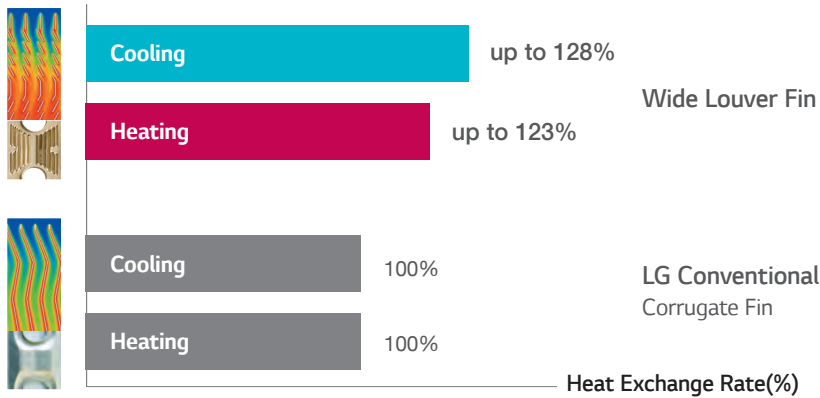

### OPTIMISED HEAT EXCHANGER PATH

Improved Refrigerant cycle efficiency up to 5% with equal distribution.

**Previous**  
Unequal distribution

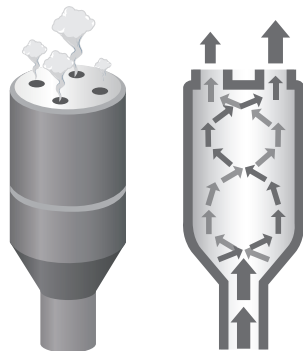

**New**  
Equal distribution

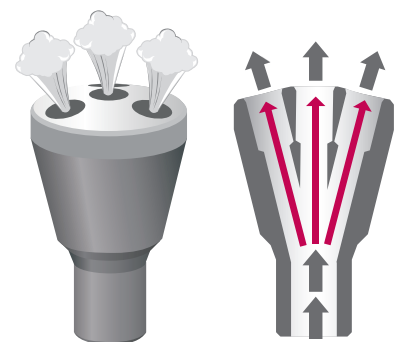

# USER FRIENDLY WALL CONTROLLER

Three optional wall controllers are available:

1. Premium wall controller -
2. Deluxe wall controller -
3. Standard wall controller -

## ▶ CONTROLLER

### • Premium Controller (optional)



PREMTA000

#### User Friendly Design

Premium design with intuitive GUI and Standard & Simple modes allows for quick and easy control of various functions and settings for up to 16 indoor units

#### Advanced Schedule Functions

Convenient schedule functions allow for the control of weekly, monthly and yearly time periods as well as effective management of seasonal cycles.

#### Intelligent Energy Management

Energy monitoring and operational run time control including temperature lock function. Graphical representation of energy usage, target energy consumption, operation time limit and alarm pop up.

### • Deluxe Wall Controller (optional)

LCD Backlit Display

Touch Screen Panel

8 Zone Control



PDRUCDCO

### • Standard (WIDE) Wall Controller (optional)

The operator can set the timing function of the air conditioner for a period of one week.



PQRCVSLOQW

LCD backlit display



Enables you to easily see the control settings.



## ► DUAL THERMISTORS CONTROL

Dual thermistor control provides the option to control temperature by referring to either of the dual temperature sensors. With the help of the slide switch at the back of the LCD wired remote controller, selection of the desired thermistor for controlling the unit can be achieved. One thermistor is in the Indoor unit & the other one is in the LCD wired remote.

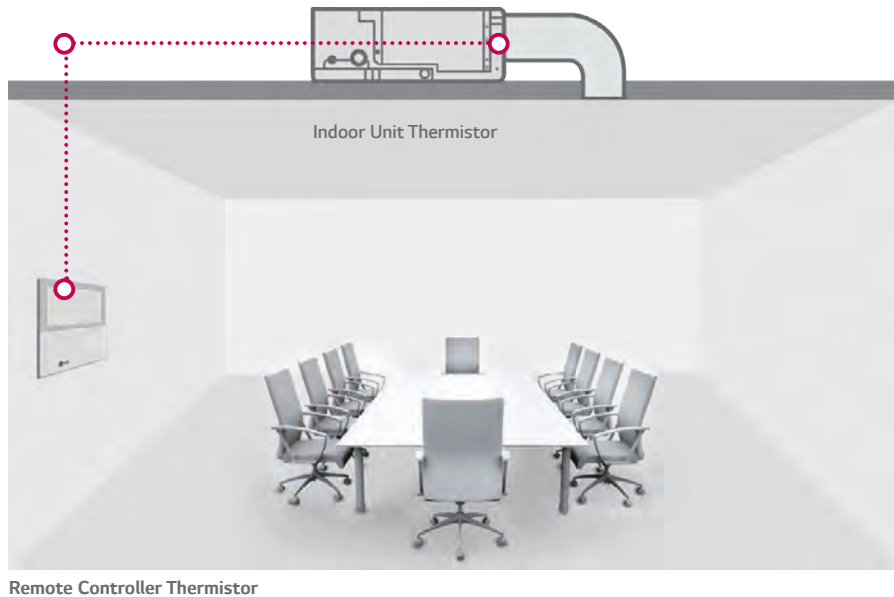

## ► OPERATION FOR MULTIPLE ROOMS

Using a duct (solid or flexible type), it is possible to operate cooling / heating for several rooms simultaneously.

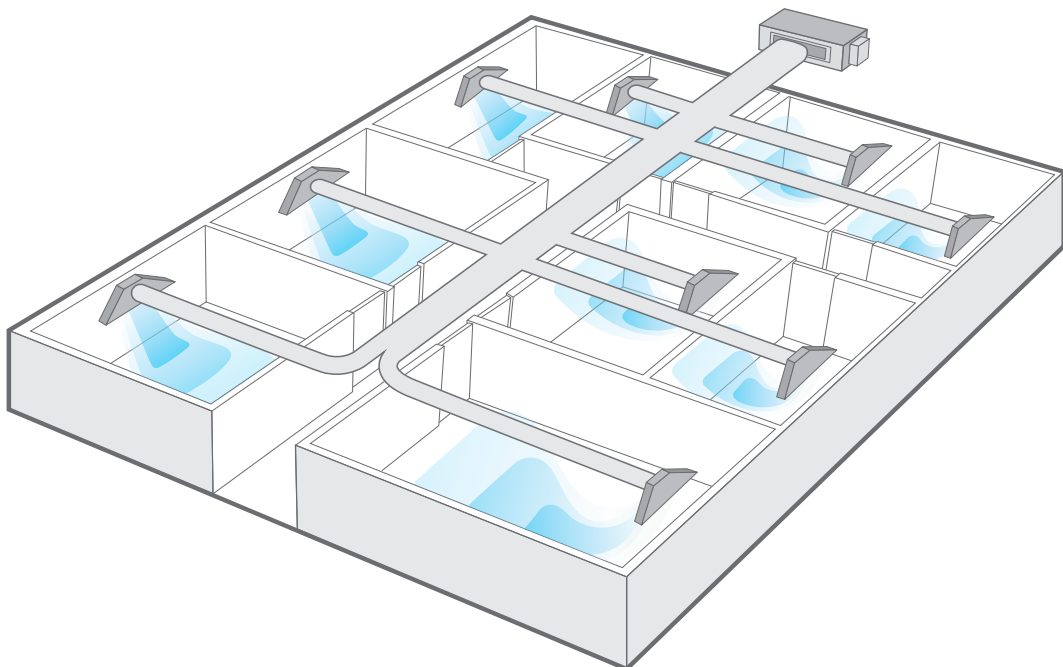

# EASY INSTALLATION & MAINTENANCE

## ▶ EASY SERVICE & MAINTENANCE (LOW/MID STATIC DUCTED)

There is now a separate panel for the heat exchanger and fan/motor. Coupled with the fan/motor filter for easy removal and installation, maintenance of the LG unit has been simplified even in limited spaces.

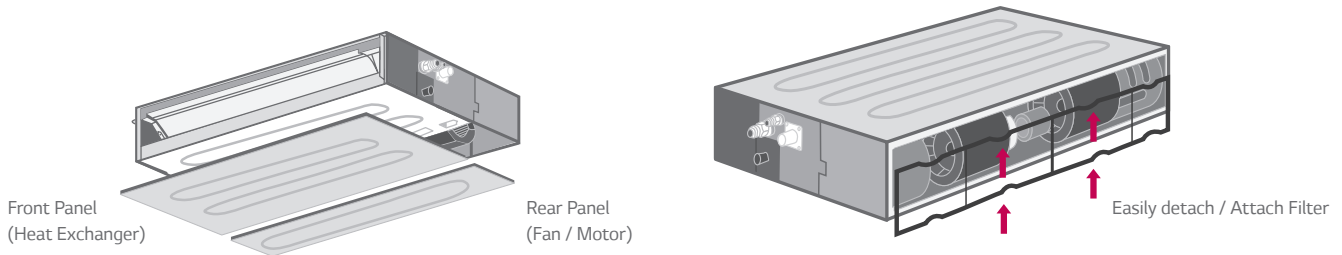

## ▶ SPLIT TYPE INDOOR UNIT

Fan/motor part assembly and heat exchanger assembly can be separated. This enables installation of the indoor unit in two parts before final assembly.

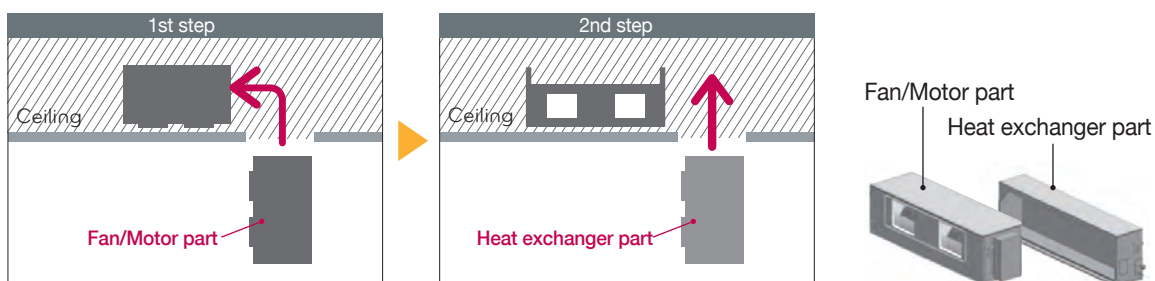

• This feature is ONLY available for B62, B70 unit.

## ▶ MINIMISED HEIGHT

New low/mid-static ducts provide ideal solution for installation in limited space.

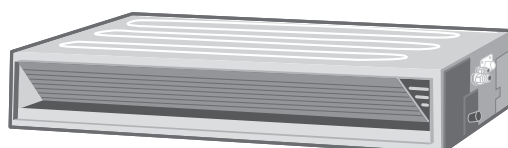
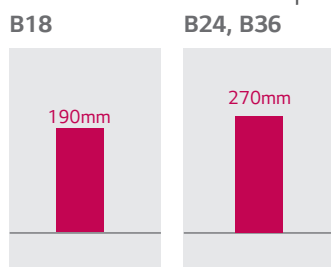



## ▶ HIGH HEAD DRAIN PUMP

Auxiliary Drain Pump automatically drains water. A standard drain-head height of up to 700mm is possible, which helps create the ideal solution for water drainage.

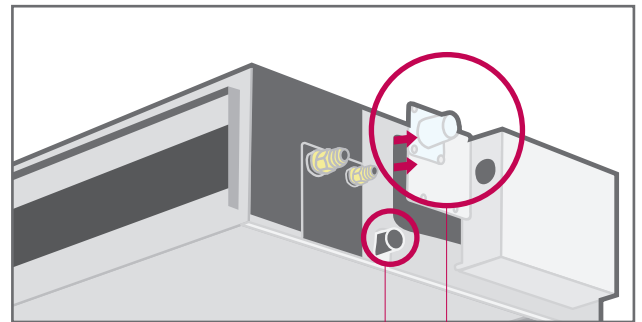
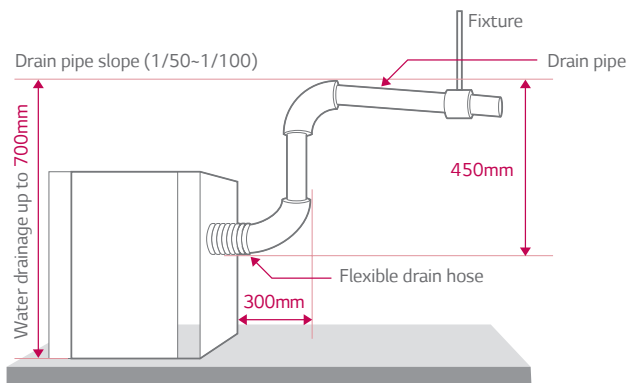

Available for natural drainage ○

Detachable drain pump ○

## ▶ FLEXIBLE INSTALLATION (LOW STATIC DUCT ONLY)

The new low static duct allows the air intake to be positioned either at the rear or bottom during installation.

### Conventional

Air intake at the only rear

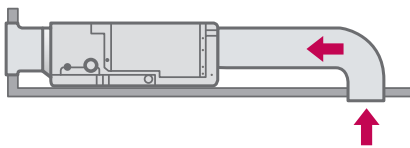

### New Low Static Duct

Air intake at the rear or bottom

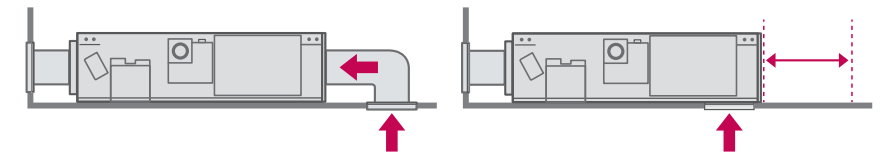

## ▶ COMPACT & LIGHT

### • Smaller Footprint

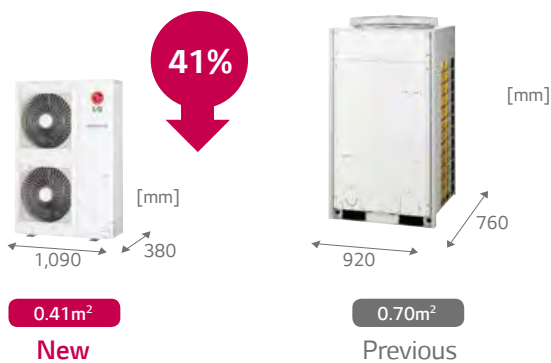

### • Lighter Weight

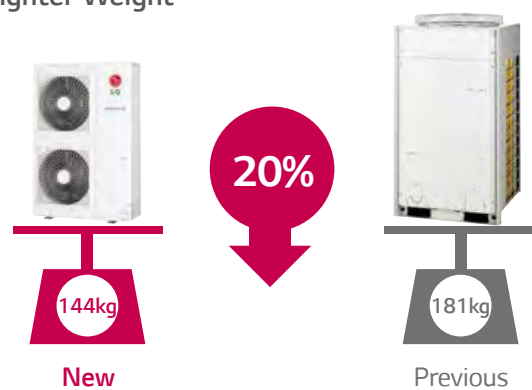

# HIGH RELIABILITY & COMFORT

**Quick** Operation Response

**Wide** Operation Range -10~48°C

**Stable** Operation Performance



## ► HIGH RELIABILITY WITH PRESSURE CONTROL

### Previous LG design

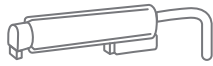

Temperature Sensor Only

#### Step 1

Sensing current temperature of refrigerant, indoor and outdoor temperature

#### Step 2

**Estimating Pressure**  
Finding recorded target pressure to operate compressor, based on the corresponding temperature data

This algorithm is more likely to be impacted by temperature change and it takes more time to calculate proper operation range of compressor to target point.

### LG Inverter

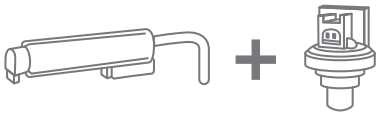

Temperature Sensor

+

Pressure Sensor

#### Step 1

Sensing refrigerant pressure and temperature simultaneously for faster and more exact response to load variation

This ensures target performance and reliable operation.

## ► QUIET OPERATION

The noise level of low static duct has been reduced, even though ESP has been increased.

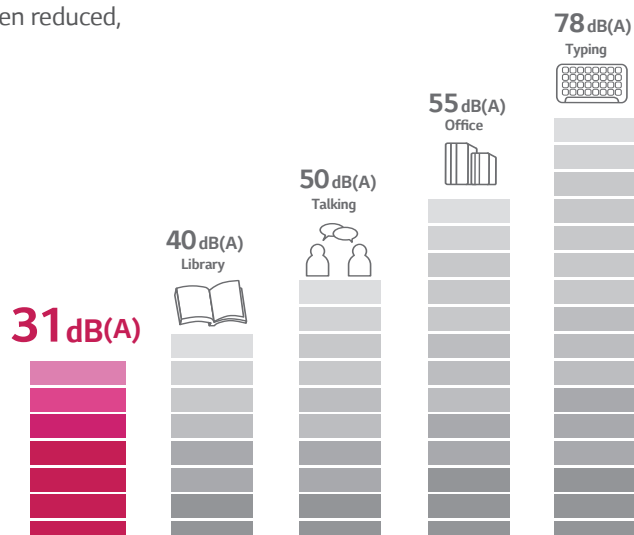





		B18AWYNGMD
Sound Pressure (High / Medium / Low)	db(A)	36 / 34 / 31



## ▶ GOLDFIN™ ANTI CORROSIVE TREATMENT

GoldFin™, is an anti corrosive treatment on the surface of the heat exchanger in the outdoor unit. The treatment is designed to protect air conditioners from pollution and corrosive conditions and assists in the durability and longevity of the unit. This technology is a great solution for harsh Australian outdoor conditions.

Salt Spray Test for 15 Days			
	After 15 Days →		
LG Gold Fin™ protected Aluminum		LG Gold Fin™ Corrosion Resistance	After 15 Days →
		Uncoated Aluminum	
			Conventional Starting to corrode

[Test Standard : ASTM B-117, KS D9502]



## ▶ E.S.P CONTROL (E.S.P: EXTERNAL STATIC PRESSURE)

Air volume can be optimised to reduce noise and meet with the system design utilising E.S.P technology. This enables you to optimise duct work installation, by maintaining airflow and sound levels as required.

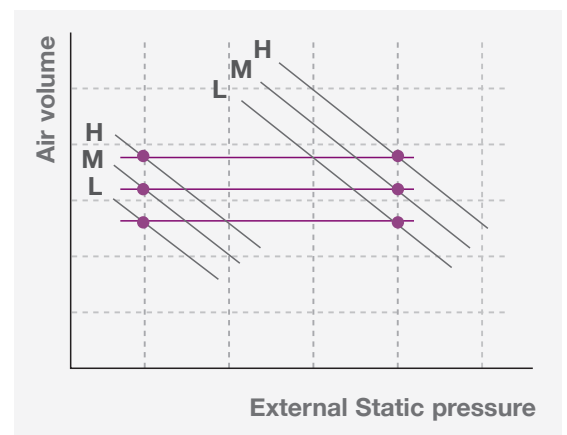

# SMART APPLICATION (OPTIONAL)

The ducted split system can be controlled by your smart phone using the LG Smart AC app. You can control settings such as on-off, operation mode (cool, heat, auto and fan), set desired temperature and adjust fan speed with the purchase of the optional WLAN module.

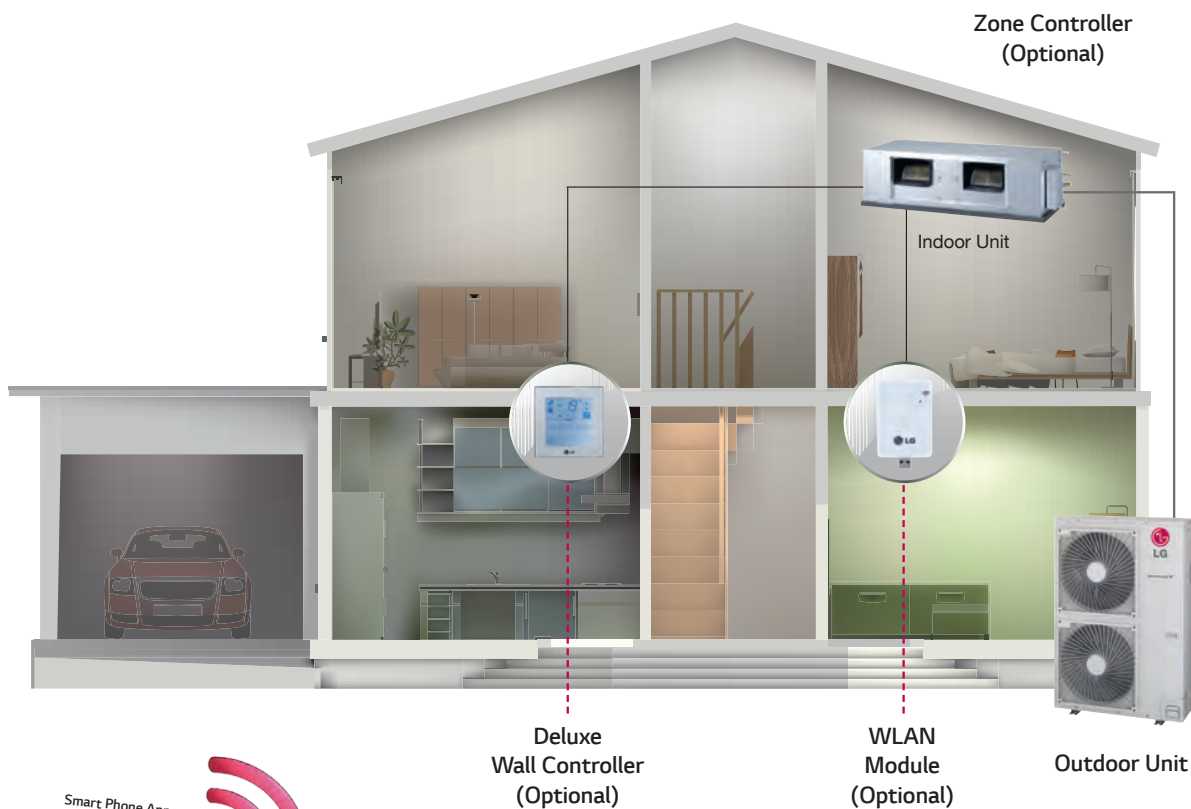

## WLAN Module (Optional)





• Not available on B18-24-36 AWYNGMD



## ▶ WI-FI SMART CONTROL

Power and temperature control from your smart phone  
LG Smart AC App lets you easily access and control your air conditioner from your smartphone

### Compatible Devices

- Android Phone (ver. 2.3 or Higher) 
- Apple iPhone (iOS6 or Higher) 
- \* Not available for Low, Mid Static model



## ▶ MY FAVOURITE SETTING

### The Perfect Setting for Me

Create your own settings with ease.

Enables you to save and easily access your favourite settings.

## ▶ ZONE CONTROL

Enables you to turn different zones on & off from your smartphone

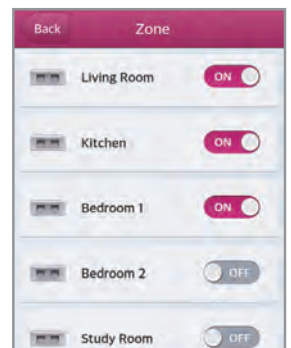

## ▶ DEMAND RESPONSE CAPABLE\*

The Demand Response Modes may be activated by the electricity supplier during periods of peak grid demand. Some electricity suppliers provide a rebate when a Demand Response Capable air conditioner is installed. You should consult your electricity supplier for further information, including rebate conditions.

\*Standard models require additional purchase of the Dry Contact accessory Part No. PQDSRCDUMO to become Demand Response Capable. A Demand Response Enabling Device (DRED) is required at the time of installation to activate the demand response modes.

Available from your installing electrician.

# INVERTER

## Slim / Low Static

### B18AWYNGMD



B18AWYUGMD



Indoor				B18AWYNGMD	
Capacity	Cooling	Min/Rated/Max	kW	2.0 / 5.1 / 6.0	
	Heating	Min/Rated/Max	kW	2.2 / 6.0 / 7.3	
Power Input	Cooling	Rated	kW	1.65	
	Heating	Rated	kW	1.82	
Power Supply			V/ø/Hz	220-240 / 1 / 50	
EER				3.09	
COP				3.30	
Piping Connection	Liquid		mm	Ø 6.35	
	Gas		mm	Ø 12.7	
	Drain	O.D./I.D.	mm	Ø 32 / 25	
Air Flow Rate		High/Medium/Low	m <sup>3</sup> /min	15.0 / 12.5 / 10.0	
			l/s	250 / 208 / 166	
Sound Pressure	Cooling	High/Medium/Low	dBA	36 / 34 / 31	
	Heating	High/Medium/Low	dBA	36 / 34 / 31	
Sound Power	Cooling	Max	dBA	54	
Dehumidification Rate			l/h	1.7	
Dimensions	Body	WxHxD	mm	900 x 190 x 700	
Net Weight	Body		kg	23.0 (50.7)	
Supply Air Spigot		WxH	mm	860 x 148	
Return Air Spigot		WxH	mm	860 x 155	
Fan Motor Output			W	19x1+5x1	
External Static Pressure (-pre set)		Min-Max	Pa	0 - (24.5) - 50	
Outdoor				B18AWYUGMD	
Compressor	Type			Twin Rotary	
Airflow Rate		Rated	m <sup>3</sup> /min	50 x 1	
			l/s	833 x 1	
Sound Pressure	Cooling	Rated	dBA	48	
	Heating	Rated	dBA	51	
Sound Power	Cooling	Max	dBA	60	
Dimensions	WxHxD		mm	870 x 655 x 320	
Net Weight			kg	46	
Refrigerant	Type			R410A	
	Charge		g	1,400	
	Additional Charge (after 7.5m)		g/m	20	
Operation Range (Outdoor)	Cooling	Min-Max	°C DB	(-)15 ~ 48	
	Heating	Min-Max	°C WB	(-)18 ~ 18	
Power Supply			V/ø/Hz	220-240 / 1 / 50	
Running Current	Cooling/Heating	Rated	A	7.2/7.9	
Power Supply Cable			N x mm <sup>2</sup>	3C x 2.5	
Transmission Cable			N x mm <sup>2</sup>	4C x 0.75	
Circuit Breaker			A	20	
Piping Length Total		Max	m	40	
Piping Elevation Difference	IDU-ODU	Max	m	30	
Piping Connection	Liquid		mm	Ø 6.35	
	Gas		mm	Ø 12.7	

Note : 1. Due to our policy of innovation some specifications may be changed without notification.

2. Capacities are in accordance with ASNS3823.1.2

Cooling: - Indoor Temperature 27°C DB / 19°C WB

- Outdoor Temperature 35°C DB / 24°C WB

Heating: - Indoor Temperature 20°C DB / 15°C WB

- Outdoor Temperature 7°C DB / 6°C WB

# INVERTER

## B24AWYNGMD B36AWYNGMD



B24AWYUGMD

B36AWYUGMD

## Slim / Mid Static

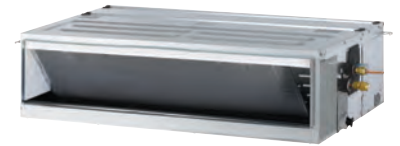

B24AWYNGMD

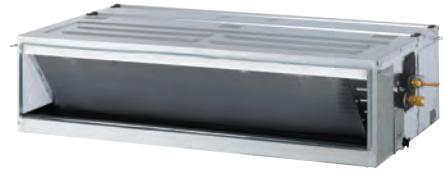

B36AWYNGMD



Indoor				B24AWYNGMD	B36AWYNGMD
Capacity	Cooling	Min/Rated/Max	kW	2.8 / 7.1 / 7.8	4.0 / 10.0 / 11.0
	Heating	Min/Rated/Max	kW	3.2 / 8.1 / 8.8	4.5 / 11.2 / 12.3
Power Input	Cooling	Rated	kW	2.03	3.24
	Heating	Rated	kW	2.23	3.36
Power Supply			V/ø/Hz	220-240 / 1 / 50	220-240 / 1 / 50
EER				3.57	3.09
COP				3.54	3.33
Piping Connection	Liquid		mm	Ø 9.52	Ø 9.52
	Gas		mm	Ø 15.88	Ø 15.88
	Drain	O.D./I.D.	mm	Ø 32 / 25	Ø 32 / 25
Air Flow Rate		High/Medium/Low	m <sup>3</sup> /min	22.0 / 20.0 / 18.0	32.0 / 28.0 / 24.0
			l/s	366 / 333 / 300	533 / 466 / 400
Sound Pressure	Cooling	High/Medium/Low	dBA	37 / 35 / 34	36 / 34 / 33
	Heating	High/Medium/Low	dBA	37 / 35 / 34	36 / 34 / 33
Sound Power	Cooling	Max	dBA	62	60
Dehumidification Rate			l/h	2.8	3.2
Dimensions	Body	WxHxD	mm	900 x 270 x 700	1,250 x 270 x 700
Net Weight	Body		kg	25.3 (55.8)	36.0 (79.4)
Supply Air Spigot		WxH	mm	857 x 200	1206 x 200
Return Air Spigot		WxH	mm	850 x 231	1205 x 231
Fan Motor Output			W	136.5 x 1	295 x 1
External Static Pressure -pre set		Min-Max	Pa	25 - 147 (58.6 factory)	25 - (58.8 factory) - 147
Outdoor				B24AWYUGMD	B36AWYUGMD
Compressor	Type			Twin Rotary	Twin Rotary
Airflow Rate		Rated	m <sup>3</sup> /min	58 x 1	45 x 2
			l/s	966 x 1	750 x 2
Sound Pressure	Cooling	Rated	dBA	48	53
	Heating	Rated	dBA	52	54
Sound Power	Cooling	Max	dBA	62	66
Dimensions	WxHxD		mm	950 x 834 x 330	950 x 1,170 x 330
Net Weight			kg	60	81
Refrigerant	Type			R410A	R410A
	Charge		g	2,000	2,800
	Additional Charge (after 7.5m)		g/m	40	40
Operation Range (Outdoor)	Cooling	Min-Max	°C DB	(-)15 ~ 48	(-)15 ~ 48
	Heating	Min-Max	°C WB	(-)18 ~ 18	(-)18 ~ 18
Power Supply			V/ø/Hz	220-240 / 1 / 50	220-240 / 1 / 50
Running Current	Cooling/Heating	Rated	A	8.8/9.7	14.1/14.6
Power Supply Cable			N x mm <sup>2</sup>	3C x 2.5	3C x 5.0
Transmission Cable			N x mm <sup>2</sup>	4C x 0.75	4C x 0.75
Circuit Breaker			A	30	40
Piping Length Total		Max	m	50	50
Piping Elevation Difference	IDU-ODU	Max	m	30	30
Piping Connection	Liquid		mm	Ø 9.52	Ø 9.52
	Gas		mm	Ø 15.88	Ø 15.88

Note : 1. Due to our policy of innovation some specifications may be changed without notification.

2. Capacities are in accordance with AS/NZS3823.1.2

Cooling: - Indoor Temperature 27°C DB / 19°C WB  
- Outdoor Temperature 35°C DB / 24°C WB

Heating: - Indoor Temperature 20°C DB / 15°C WB  
- Outdoor Temperature 7°C DB / 6°C WB



# INVERTER

**B30AWYN7G5**  
**B36AWYN7G5**  
**B42AWYN7G5**  
**B55AWYN7G5**

Premium / High Static



Indoor				B30AWYN7G5	B36AWYN7G5	B42AWYN7G5	B55AWYN7G5
Capacity	Cooling	Min/Rated/Max	kW	3.2 / 8.8 / 9.6	4.1 / 9.9 / 11.0	4.9 / 12.3 / 14.8	6.4 / 15.0 / 17.1
	Heating	Min/Rated/Max	kW	3.7 / 9.2 / 11.0	4.4 / 11.0 / 12.1	5.6 / 14.1 / 16.9	7.0 / 17.1 / 18.0
Power Input	Cooling	Rated	kW	2.85	2.9	3.65	4.85
	Heating	Rated	kW	2.8	3.28	3.82	5.20
Power Supply			V/ø/Hz	230~240 / 1 / 50	230~240 / 1 / 50	230~240 / 1 / 50	230~240 / 1 / 50
EER				3.09	3.41	3.37	3.09
COP				3.29	3.35	3.69	3.29
Piping Connection	Liquid		mm	ø 9.52	ø 9.52	ø 9.52	ø 9.52
	Gas		mm	ø 15.88	ø 15.88	ø 15.88	ø 15.88
	Drain	O.D./I.D.	mm	ø 32/25	ø 32/25	ø 32/25	ø 32/25
Air Flow Rate		High/Medium/Low	m <sup>3</sup> /min	32.0 / 26.0 / 20.0	42.0 / 36.0 / 28.0	48.0 / 42.0 / 36.0	60.0 / 50.0 / 40.0
			l/s	533/433/333	700/600/467	800/700/600	1000/833/667
Sound Pressure	Cooling	High/Medium/Low	dBA	44/43/42	45/44/43	46/45/44	46/45/44
	Heating	High/Medium/Low	dBA	44/43/42	45/44/43	46/45/44	46/45/44
Sound Power	Cooling	Max	dBA	-	-	-	-
Dehumidification Rate			l/h	1.8	3.0	2.7	4.0
Dimensions	Body	WxHxD	mm	1,320 X 400 X 534	1,320 X 400 X 534	1,320 X 400 X 534	1,320 X 400 X 534
Net Weight	Body		kg	48	48	52	52
Supply Air Spigot		WxH	mm	840 X 287	840 X 287	840 X 287	840 X 287
Return Air Spigot		WxH	mm	1,172 X 317	1,172 X 317	1,172 X 317	1,172 X 317
Fan Motor Output			W	350 X 1	350 X 1	185 X 2	185 X 2
External Static Pressure -pre set		Min-Max	Pa	62-200(130 factory)	62-200(130 factory)	62-200(130 factory)	62-200(130 factory)
Outdoor				B30AWYU4G5	B36AWYU4G5	B42AWYU3G5	B55AWYU3G5
Compressor	Type			Twin Rotary	Twin Rotary	Twin Rotary	Twin Rotary
Airflow Rate	Rated		m <sup>3</sup> /min	58	45×2	55×2	55×2
			l/s	967	750*2	917*2	917*2
Sound Pressure	Cooling	Rated	dBA	48	53	52	52
	Heating	Rated	dBA	52	54	54	54
Sound Power	Cooling	Max	dBA	65	66	67	71
Dimensions	WxHxD		mm	950 X 834 X 330	950 X 1,170 X 330	950 X 1,380 X 330	950 X 1,380 X 330
Net Weight			kg	60.0	81.0	92.0	92.0
Refrigerant	Type			R410A	R410A	R410A	R410A
	Charge		g	2,000	2,800	3,400	3,400
	Additional Charge (after 7.5m)		g/m	40	30	40	40
Operation Range (Outdoor)	Cooling	Min-Max	°C DB	-10 ~ 48	-10 ~ 48	-10 ~ 48	-10 ~ 48
	Heating	Min-Max	°C WB	-15 ~ 18	-15 ~ 18	-15 ~ 18	-15 ~ 18
Power Supply			V/ø/Hz	220~240 / 1 / 50	220~240 / 1 / 50	220~240 / 1 / 50	220~240 / 1 / 50
Running Current	Cooling/Heating	Rated	A	12.7/11.3	12.4/14.5	16.0/17.0	21.0/22.7
Power Supply Cable			N x mm <sup>2</sup>	3 x 2.5	3 x 5.0	3 x 5.0	3 x 5.0
Transmission Cable			N x mm <sup>2</sup>	4 x 1.0	4 x 1.0	4 x 1.0	4 x 1.0
Circuit Breaker			A	25	40	40	40
Piping Length Total		Max	m	50	50	50	50
Piping Elevation Difference	IDU-ODU	Max	m	30	30	30	30
Piping Connection	Liquid		mm	ø 9.52	ø 9.52	ø 9.52	ø 9.52
	Gas		mm	ø 15.88	ø 15.88	ø 15.88	ø 15.88

Note : 1. Due to our policy of innovation some specifications may be changed without notification.

2. Capacities are in accordance with ASNS3823.1.2

Cooling: - Indoor Temperature 27°C DB / 19°C WB

- Outdoor Temperature 35°C DB / 24°C WB

Heating: - Indoor Temperature 20°C DB / 15°C WB

- Outdoor Temperature 7°C DB / 6°C WB

# INVERTER

**B30AWYN7G5A**  
**B36AWYN7G5A**  
**B42AWYN7G5A**  
**B55AWYN7G5A**

Standard / High Static

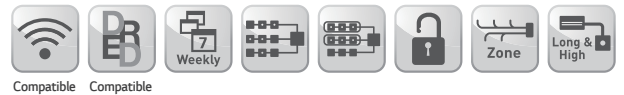

Indoor				B30AWYN7G5A	B36AWYN7G5A	B42AWYN7G5A	B55AWYN7G5A
Capacity	Cooling	Min/Rated/Max	kW	3.2 ~ 8 ~ 8.8	4.1 ~ 9.9 ~ 11.0	4.9 / 12.3 / 13.5	6.4 / 14.2 / 16.2
	Heating	Min/Rated/Max	kW	3.7 ~ 8.8 ~ 9.6	4.4 ~ 11.0 ~ 12.1	5.6 / 14.1 / 15.50	7.0 / 17.1 / 18.0
Power Input	Cooling	Rated	kW	2.59	3.01	4.08	4.73
	Heating	Rated	kW	2.67	3.35	4.03	5.20
Power Supply			V/ø/Hz	220-240 / 1 / 50	220-240 / 1 / 50	220-240 / 1 / 50	220-240 / 1 / 50
EER				3.09	3.29	3.01	3.00
COP				3.29	3.28	3.50	3.29
Piping Connection	Liquid		mm	Ø 9.52	Ø 9.52	Ø 9.52	Ø 9.52
	Gas		mm	Ø 15.88	Ø 15.88	Ø 15.88	Ø 15.88
	Drain	O.D./I.D.	mm	Ø 32 / 25	Ø 32 / 25	Ø 32 / 25	Ø 32 / 25
Air Flow Rate		High/Medium/Low	m <sup>3</sup> /min	32.0 / 26.0 / 20.0	42.0 / 36.0 / 28.0	48.0 / 42.0 / 36.0	60.0 / 50.0 / 40.0
			l/s	533 / 433 / 333	700 / 600 / 467	800 / 700 / 600	1,000 / 833 / 667
Sound Pressure	Cooling	High/Medium/Low	dBA	44 / 43 / 42	45 / 44 / 43	45 / 44 / 43	46 / 45 / 44
	Heating	High/Medium/Low	dBA	44 / 43 / 42	45 / 44 / 43	45 / 44 / 43	46 / 45 / 44
Sound Power	Cooling	Max	dBA	-	-	-	-
Dehumidification Rate			l/h	1.8	3.0	2.7	4.0
Dimensions	Body	WxHxD	mm	1,320 × 400 × 534	1,320 × 400 × 534	1,320 × 400 × 534	1,320 × 400 × 534
Net Weight	Body		kg	48 (105.8)	48 (105.8)	48 (105.8)	48 (105.8)
Supply Air Spigot		WxH	mm	840 × 287	840 × 287	842 × 291	842 × 291
Return Air Spigot		WxH	mm	1,172 × 317	1,172 × 317	1,152 × 317	1,152 × 317
Fan Motor Output			W	350 x 1	350 x 1	400 x 1	195 x 2
External Static Pressure (-pre set)		Min-Max	Pa	60 - 200 (60 factory)	60 - 200 (60 factory)	60 - 200 (60 factory)	60 - 200 (60 factory)
Outdoor				B30AWYU4G5A	B36AWYU4G5A	B42AWYU3G5A	B55AWYU3G5A
Compressor	Type			Twin Rotary	Twin Rotary	Twin Rotary	Twin Rotary
Airflow Rate		Rated	m <sup>3</sup> /min	58 x 1	45 x 2	45 x 2	55 x 2
			l/s	966 x 1	750 x 2	750 x 2	916 x 2
Sound Pressure	Cooling	Rated	dBA	48	53	53	54
	Heating	Rated	dBA	52	54	54	56
Sound Power	Cooling	Max	dBA	65	66	66	71
Dimensions	WxHxD		mm	870 × 808 × 320	950 × 1,170 × 330	950 × 1,170 × 330	950 × 1,380 × 330
Net Weight			kg	56	78	78	88
Refrigerant	Type			R410A	R410A	R410A	R410A
	Charge		g	2,200	2,800	2,800	3,300
	Additional Charge (after 20m)		g/m	40	40	40	40
Operation Range (Outdoor)	Cooling	Min-Max	°C DB	(-)10 ~ 48	(-)10 ~ 48	(-)10 ~ 48	(-)10 ~ 48
	Heating	Min-Max	°C WB	(-)10 ~ 24	(-)10 ~ 24	(-)10 ~ 24	(-)10 ~ 24
Power Supply			V/ø/Hz	220-240 / 1 / 50	220-240 / 1 / 50	220-240 / 1 / 50	220-240 / 1 / 50
Running Current	Cooling/Heating	Rated	A	11.6/12.0	13.5/15.0	17.8/17.0	21.8/22.7
Power Supply Cable			N x mm <sup>2</sup>	3C x 2.5	3C x 6.0	3C x 6.0	3C x 6.0
Transmission Cable			N x mm <sup>2</sup>	4C x 0.75	4C x 0.75	4C x 0.75	4C x 0.75
Circuit Breaker			A	40	40	40	40
Piping Length Total		Max	m	50	50	50	50
Piping Elevation Difference	IDU-ODU	Max	m	30	30	30	30
Piping Connection	Liquid		mm	Ø 9.52	Ø 9.52	Ø 9.52	Ø 9.52
	Gas		mm	Ø 15.88	Ø 15.88	Ø 15.88	Ø 15.88

Note : 1. Due to our policy of innovation some specifications may be changed without notification.

2. Capacities are in accordance with ASNZS3823.1.2

Cooling: - Indoor Temperature 27°C DB / 19°C WB Heating: - Indoor Temperature 20°C DB / 15°C WB  
 - Outdoor Temperature 35°C DB / 24°C WB - Outdoor Temperature 7°C DB / 6°C WB

# INVERTER

## B62AWYN9L6

## Big Duct / High Static



B62AWYU7L6



Indoor				B62AWYN9L6
Capacity	Cooling	Min / Nom / Max	kW	7.2 ~ 18.0 ~ 19.8
	Heating	Min / Nom / Max	kW	8.2 ~ 20.6 ~ 22.7
Power Input	Cooling	Rated	kW	5.47
	Heating	Rated	kW	5.49
EER			W	3.29
COP			W	3.75
Power Supply			ø / V / Hz	220-240 / 1 / 50
Dimension	Body	W x H x D	mm	1,563 x 458 x 791
Net Weight	Body		kg	89
Fan	Type			Sirocco Fan
	Air Flow Rate (Standard Mode)	H / M / L	L/S m <sup>3</sup> /min	1,333 / 1,200 / 1,067 80/72/64
Supply Air Spigot		W x H	mm	1044 x 286
Return Air Spigot		W x H	mm	1368 x 392
External Static Pressure (-pre set)		Min-Max	Pa	60 - 180 (130 factory)
Dehumidification Rate			l/h	1.35
Sound Pressure	Cooling	H / M / L	dB(A)	43 / 41 / 40
	Liquid		mm (inch)	ø12.7 (1/2)
Piping Connections	Gas		mm (inch)	ø22.2 (7/8)
	Drain (O.D / I.D)		mm	ø32.0 / 25.0
Outdoor				B62AWYU7L6
Compressor	Type			Hermetically Sealed Scroll
Power Supply			ø / V / Hz	380-415 / 3 / 50
Running Current	Cooling	Rated	A	9.3
	Heating	Rated	A	9.6
Dimension		W x H x D	mm	1,090 x 1,625 x 380
Net Weight			kg	144
Refrigerant	Type			R410A
	Pre-charged Amount		g	5,500
	Additional Charge (after 15m)		g/m	70
Sound Pressure Level	Cooling	Rated	dB(A)	59
	Heating	Rated	dB(A)	60
Sound Power Level	Cooling		dB(A)	71
Piping Connections	Liquid	Outer Dia.	mm	ø12.7
	Gas	Outer Dia.	mm	ø22.2
Piping Length		Max.	m (ft)	75 (246.0)
Maximum Hight	O.D.U ~ I.D.U	Max.	m (ft)	30 (98.4)
Operation Range (Outdoor Temperature)	Cooling	Min ~ Max.	°C DB	-20 ~ 48
	Heating	Min ~ Max.	°C WB	-18 ~ 18

Note : 1. Due to our policy of innovation some specifications may be changed without notification.

2. Capacities are in accordance with AS/NZS3823.1.2

Cooling: - Indoor Temperature 27°C DB / 19°C WB  
- Outdoor Temperature 35°C DB / 24°C WB

Heating: - Indoor Temperature 20°C DB / 15°C WB  
- Outdoor Temperature 7°C DB / 6°C WB



# INVERTER

## Big Duct / High Static

### B70AWYN9L6



B70AWYU7L6

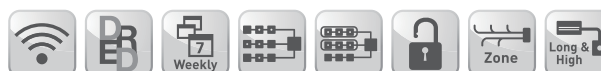

Indoor				B70AWYN9L6
Capacity	Cooling	Min / Nom / Max	kW	8.0 ~ 20.0 ~ 22.0
	Heating	Min / Nom / Max	kW	9.0 ~ 22.6 ~ 24.9
Power Input	Cooling	Rated	kW	6.47
	Heating	Rated	kW	6.19
EER			W	3.09
COP			W	3.65
Power Supply			ø / V / Hz	220-240 / 1 / 50
Dimension	Body	W x H x D	mm	1,563 x 458 x 791
Net Weight	Body		kg	89
Fan	Type			Sirocco Fan
	Air Flow Rate (Standard Mode)	H / M / L	L/S m <sup>3</sup> /min	1,333 / 1,200 / 1,067 80/72/64
Supply Air Spigot		W x H	mm	1044 x 286
Return Air Spigot		W x H	mm	1368 x 392
External Static Pressure (-pre set)		Min-Max	Pa	60 - 180 (130 factory)
Dehumidification Rate			l/h	3.13
Sound Pressure	Cooling	H / M / L	dB(A)	43 / 41 / 40
	Liquid		mm (inch)	ø12.7 (1/2)
Piping Connections	Gas		mm (inch)	ø22.2 (7/8)
	Drain (O.D / I.D)		mm	ø32.0 / 25.0
Outdoor				B70AWYU7L6
Compressor	Type			Hermetically Sealed Scroll
Power Supply			ø / V / Hz	380-415 / 3 / 50
Running Current	Cooling	Rated	A	10.9
	Heating	Rated	A	10.5
Dimension		W x H x D	mm	1,090 x 1,625 x 380
Net Weight			kg	144
Refrigerant	Type			R410A
	Pre-charged Amount		g	5,500
	Additional Charge (after 15m)		g/m	70
Sound Pressure Level	Cooling	Rated	dB(A)	59
	Heating	Rated	dB(A)	60
Sound Power Level	Cooling		dB(A)	71
Piping Connections	Liquid	Outer Dia.	mm	ø12.7
	Gas	Outer Dia.	mm	ø22.2
Piping Length		Max.	m (ft)	75 (246.0)
Maximum Hight	O.D.U ~ I.D.U	Max.	m (ft)	30 (98.4)
Operation Range (Outdoor Temperature)	Cooling	Min ~ Max.	°C DB	-20 ~ 48
	Heating	Min ~ Max.	°C WB	-18 ~ 18

Note : 1. Due to our policy of innovation some specifications may be changed without notification.

2. Capacities are in accordance with AS/NZS3823.1.2

Cooling: - Indoor Temperature 27°C DB / 19°C WB  
- Outdoor Temperature 35°C DB / 24°C WB

Heating: - Indoor Temperature 20°C DB / 15°C WB  
- Outdoor Temperature 7°C DB / 6°C WB

# ACCESSORY

## Central Control

Control Method	Objective/Use	Unit Name and Model	Function	Parts	Features
<p><b>AC-EZ</b> <b>PQCSZ250S0</b></p>	<p>Provides a centralised point where up to 32 indoor units or indoor unit groups can be controlled and monitored</p>		<ul style="list-style-type: none"> <li>• Remote control &amp; Monitor</li> <li>• 8 programmable schedules with mode and set point control</li> <li>• Error code display during unit or system malfunction</li> </ul>	<ul style="list-style-type: none"> <li>• Controller</li> <li>• Manual</li> <li>• Screw 6EA</li> <li>• Screw 4EA</li> </ul>	<ul style="list-style-type: none"> <li>• LED indicator for operating status</li> <li>• Max 32 IDU control</li> </ul>

**AC-Smart Premium**  
**PQCSW421E0A**

Provides a centralised point where up to 128 indoor units or indoor unit groups can be controlled and monitored





- Visual navigation (structure mapping)
- Remote control & Monitor
- Web control
- Email error alarm

- Controller
- Manual

- 10.2 inch touch screen with user friendly GUI





\*All central control devices require PI485 interface per outdoor unit

Control Method	Objective/Use	Unit Name and Model	Function	Parts	Features
<b>ACP</b> <b>PQCPC22NO</b> <b>PQCPC22AO</b>	To control all indoor unit just like remote controller		<ul style="list-style-type: none"> <li>• Control/Monitoring</li> <li>• Schedule</li> <li>• History</li> <li>• Peak Power Control</li> <li>• PDI Monitoring</li> <li>• Setting Max 256 Indoor units Without IO (Install with AC Manager, Interlocking is impossible)</li> </ul>	<ul style="list-style-type: none"> <li>• ACP</li> <li>• Power cord</li> <li>• Manual</li> </ul>	<ul style="list-style-type: none"> <li>• Embedded web server (Can connected internet)</li> <li>• Include Central Program in the ACP Web Server</li> <li>• Directly IP Setting by using key &amp; LCD</li> <li>• Without DI/DO Port</li> </ul>
<b>AC Manager</b> <b>PQCSSA21E0</b>	To control all indoor unit just like remote controller		<ul style="list-style-type: none"> <li>• Control/Monitoring</li> <li>• Schedule</li> <li>• History</li> <li>• Peak Power Control</li> <li>• Auto control (Auto Changeover, temperature limit control)</li> <li>• Interlocking PDI data Manage</li> <li>• Setting Max 8,192 Indoor units</li> </ul>	<ul style="list-style-type: none"> <li>• PC S/W(CD)</li> <li>• Lock key</li> <li>• Manual</li> </ul>	<ul style="list-style-type: none"> <li>• Install with several ACP supply more detail control &amp; upgraded function Print &amp; down with excel of all data</li> <li>• Function Lock &amp; Set</li> <li>• Temp range restriction</li> <li>• Icon/List View individual unit operating time manage</li> <li>• Max 32 ACP connectable (Max 8,192 Indoors)</li> </ul>



# ACCESSORY

## Interface Device

Control Method	Objective/Use	Unit Name and Model	Function	Parts	Features
<b>PI485</b> <b>PMNFP14A0</b>	To connect Outdoor unit to CNU or Simple Central Controller		<ul style="list-style-type: none"> <li>• RS485 Converter with software</li> <li>• For Max.16 Indoor</li> </ul>	<ul style="list-style-type: none"> <li>• PCB Assembly</li> <li>• Bracket</li> <li>• Lead wire: 3ea</li> <li>• Screw 4EA</li> <li>• Tie wrap</li> <li>• Clamp</li> <li>• Manual</li> </ul>	<ul style="list-style-type: none"> <li>• 1 set/1 Outdoor</li> </ul>
<b>Dry Contact</b> <b>PQDSA1/</b> <b>PQDSB1</b>	For connect Indoor unit to other Forced on/off Controller	 	<ul style="list-style-type: none"> <li>• RS485 Converter with software</li> </ul>	<ul style="list-style-type: none"> <li>• PCB Assembly</li> <li>• Top case</li> <li>• Bottom case</li> <li>• Screw</li> <li>• Lead wire 3</li> <li>• Sub PCB set (1 leadwire + 1 sub PCB)</li> <li>• Manual</li> </ul>	<ul style="list-style-type: none"> <li>• 1 set/1 Indoor unit</li> <li>• PQDSB1 (24V)</li> <li>• PQDSA1 (24V)</li> </ul>
<b>Dry Contact</b> <b>PQDSBC/</b> <b>PQDSRCDUMO*</b>	For connect Indoor unit to other Forced on/off Controller	 	<ul style="list-style-type: none"> <li>• Contact signal to air-con signal converter</li> </ul>	<ul style="list-style-type: none"> <li>• PCB Assembly</li> <li>• Top/Bottom case</li> <li>• Screw</li> <li>• Lead wire 3ea</li> <li>• Sub PCB set (1 leadwire + 1 sub PCB)</li> <li>• Manual</li> </ul>	<ul style="list-style-type: none"> <li>• 1 set/1 indoor unit</li> <li>• 2 Contact points</li> <li>• No need AC input</li> <li>• Expected temperature setting is possible</li> </ul>

\*Dred/Dry contact.

## Building Management Devices

Control Method	Objective/Use	Unit Name and Model	Function	Parts	Features
<b>BNU-LW</b> <b>PLNWKB000</b>	To connect PI485 to LONWORKS BMS system		<ul style="list-style-type: none"> <li>Interface between BMS and LG air-conditioners (LonMark certified : Operation system based on LNS)</li> </ul>	<ul style="list-style-type: none"> <li>Interface Assembly</li> <li>12V DC adaptor</li> <li>Manual</li> </ul>	<ul style="list-style-type: none"> <li>64 indoor units</li> <li>ACP function (central controller) included</li> </ul>
<b>BNU-BAC</b> <b>PQNFB17C 0</b>	To connect PI485 to BACnet BMS system		<ul style="list-style-type: none"> <li>Interface between BMS and LG air-conditioners (BTL certified : Operation system based on BACnet service)</li> </ul>	<ul style="list-style-type: none"> <li>Interface Assembly</li> <li>12V DC adaptor</li> <li>Manual</li> </ul>	<ul style="list-style-type: none"> <li>256 Indoor units</li> <li>ACP function (central controller) included</li> <li>BTL certification (B-ASC)</li> </ul>
<b>PDI</b> <b>PQNUD1S00</b>	To Power consumption Distribution of each indoor unit		<ul style="list-style-type: none"> <li>Accumulation of total power consumption</li> <li>Indication of current power in use</li> <li>Indication of accumulated power for period</li> <li>Indication of standby power (option setting)</li> </ul>	<ul style="list-style-type: none"> <li>PDI Assembly Manual</li> </ul>	<ul style="list-style-type: none"> <li>1 PDI / 1 Outdoor</li> </ul>
<b>PDI Premium</b> <b>PQNUD1S40</b>	To power consumption distribution of each indoor unit		<ul style="list-style-type: none"> <li>Accumulation of total power consumption</li> <li>Indication of current power in use</li> <li>Indication of accumulated power for period</li> <li>Indication of standby power</li> <li>Blackout protection</li> </ul>	<ul style="list-style-type: none"> <li>PDI Assembly manual</li> </ul>	<ul style="list-style-type: none"> <li>1 PDI / 8 Outdoor</li> </ul>

1) PI485 : Product Interface unit for RS 485 transmission







## NEW SOUTH WALES / HEAD OFFICE

2 Wonderland Drive EASTERN CREEK NSW 2766  
PH : 02-8805-4000 FAX : 02-8805-4248

## QUEENSLAND

23 Terrace Place MURARRIE QLD 4172  
PH : 07-3908-9000 FAX : 07-3399-4179

## VICTORIA

3 John Deere Court, Parkwest Estate DERRIMUT VIC 3030  
PH : 03-8369-0900 FAX : 03-9931-0677

## SOUTH AUSTRALIA

162 Richmond Road MARLESTON SA 5033  
PH : 08-8238-0200 FAX : 08-8238-0299

## WESTERN AUSTRALIA

Unit 1/1A 2 Business Way Malaga  
PO Box 1724 Malaga WA 6944  
PH : 08-9249-3721 FAX : 08-9249-1300

Customer Information Centre is available 7 days  
from 7AM-7PM on 1300 54 2273 (1300 LG CARE)  
SMS Fault call 0400 660 629  
[www.lge.com.au](http://www.lge.com.au)

## NEW ZEALAND

LG House, Level 1, Building 2, 60 Highbrook Drive,  
East Tamaki, Auckland, 2013, New Zealand  
Tel : +64 (09) 914 2444 Fax : +64 (09) 914 2441  
Customer Service Helpline  
0800 54 2273 (0800 LG CARE)  
[www.lge.com/nz](http://www.lge.com/nz)



### Warranty Brief

- All LG Electronics Air Conditioning Units are covered by a 5-Year Parts and Labour Warranty when used in Residential Applications. Commercial Applications attract a 5-Year Parts and Labour Warranty.\*
  - Air Conditioning units carry an on-site warranty.\*
- \*Further conditions apply, see the Warranty Card for further information.



LG Electronics Changwon Facility Achieved ISO9001 Certification Under Series 9000 of International Standard Organization(ISO) Based on Quality Systems For Design & Manufacture of Air Conditioners, Hermetic Refrication Compressors.

© LG Electronics Australia Pty., Ltd. Printed in Korea

### Disclaimer

The descriptions and specifications in this brochure are relevant as at the date of publication June 2015. In the interest of product development, LG Electronics reserves the right to carry out alterations and improvements to products and specifications. Future releases of products, accessories and parts for them may differ from, and may not be compatible with current versions. As it may be difficult to determine the exact nature of a product from its depiction in this brochure. LG Electronics strongly recommends that you confirm with your retailer that the product shown or described in this brochure meets your requirements before you purchase the product.